



PANEL
DESIGN



PANELES PUERTA
SEGURIDAD DISEÑO MÚLTIPLES POSIBILIDADES



En **PANELDESIGN** contamos con la última tecnología en fabricación de paneles de puerta en aluminio y PVC para un óptimo aislamiento térmico y acústico al mismo tiempo que protege su hogar.

Las diferentes series que **PANELDESIGN** pone a su disposición se adaptan a la perfección a los diferentes estilos arquitectónicos o proyectos de reforma y están disponibles en 26 colores a base de folio decorativo de alta resistencia, lacados según carta RAL o PVC blanco.

Sea cuál sea el proyecto, obra o reforma en **PANELDESIGN** encontrará un amplio abanico de soluciones y diseños y contará con el apoyo comercial y técnico que usted necesita.



ASICA
series

pág. 01-04



MOLDURA
series

pág. 19-26



LISA
series

pág. 05-14



TERMOCONFORMADA
series

pág. 27-28



CANALADA
series

pág. 15-18



ÚSTICA
series

pág. 29-32

bÁSICA
series



La serie básica combina de forma sencilla paneles de máxima calidad y acero inoxidable con accesorios a juego consiguiendo unos diseños de gran simplicidad y belleza.

Paneles en diferentes colores madera y lisos combinados elegantemente con canales o pletinas de acero que le confieren un aspecto elegante, moderno y duradero.

Posibilidad de incorporar diferentes manillas y tiradores para potenciar todavía más su aspecto minimalista y a un precio muy competitivo al no incorporar vidrios en toda la serie.

800 / 900*

2000 / 2100*

* Medidas máximas de corte variable.









La acertada combinación de texturas y materiales para unos diseños sobrios, elegantes y que se integran a la perfección en una amplia gama de estilos y proyectos.

La amplia disponibilidad de modelos dentro de esta serie se explica por las múltiples posibilidades de aplicación y combinaciones que se pueden hacer con los diferentes colores, vidrios y acero inoxidable. Incluso en aquellos modelos en los que se usa como base el PVC blanco el resultado es sorprendente.

Se trata de una serie amplia, versátil y de novedosos diseños.

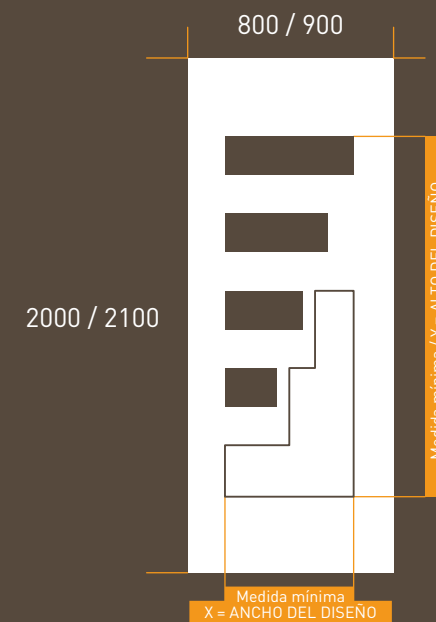

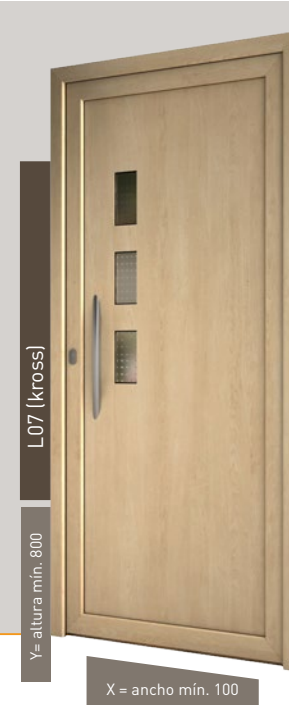
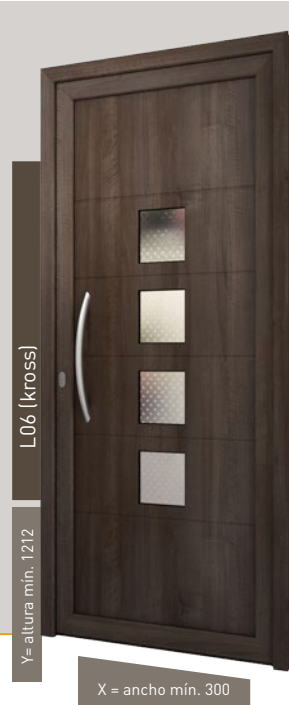
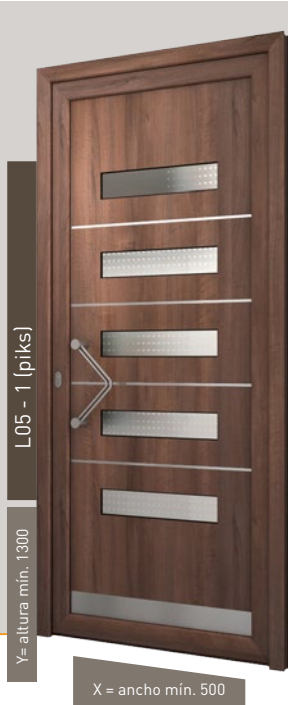



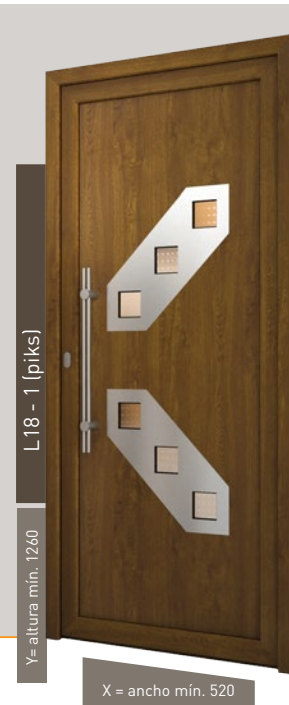
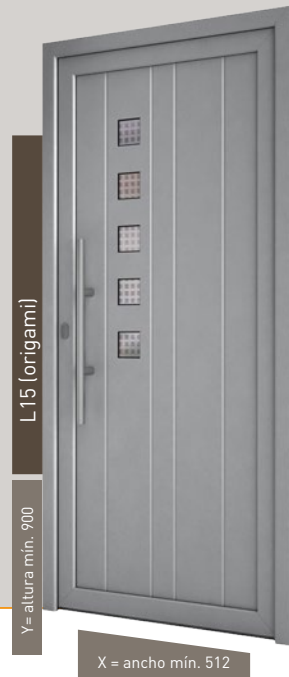



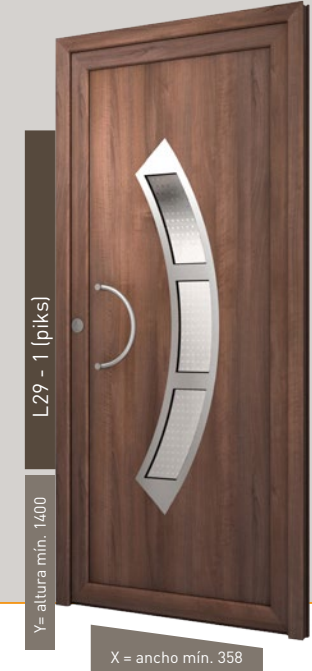
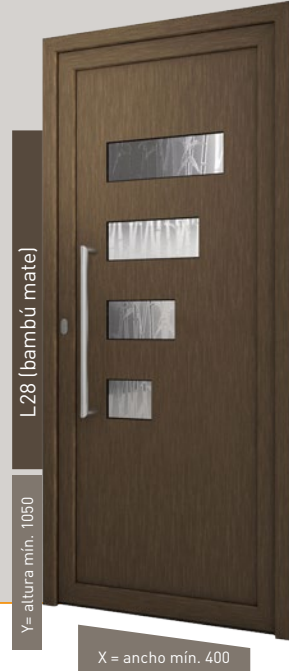
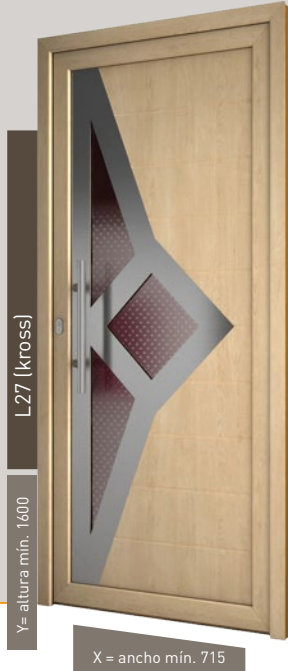

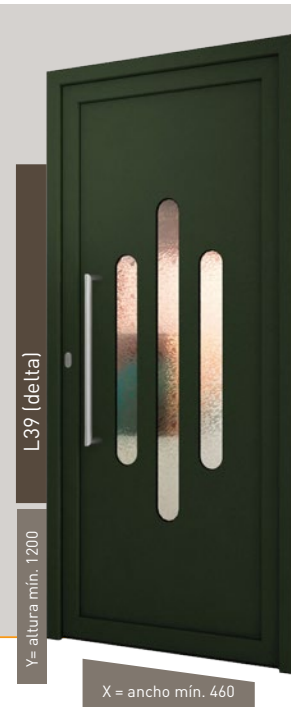
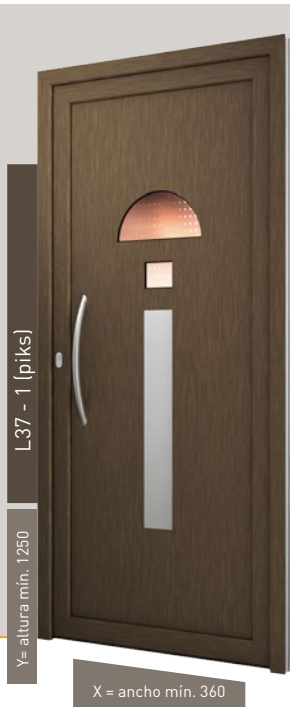
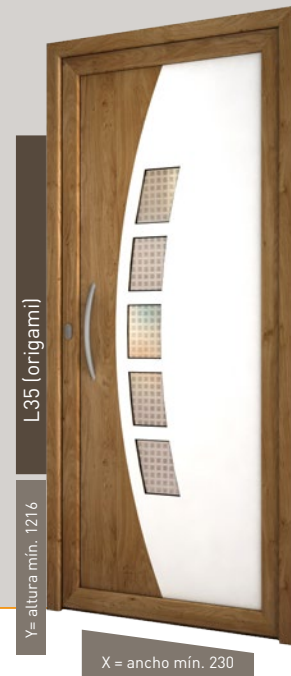
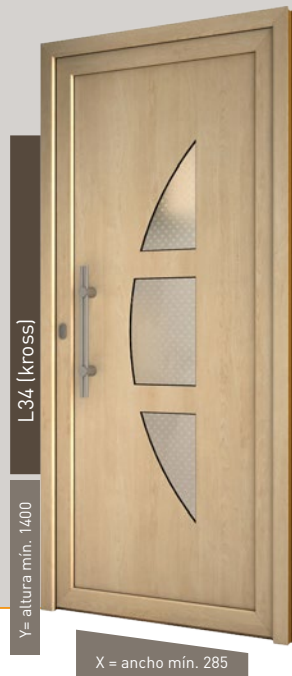

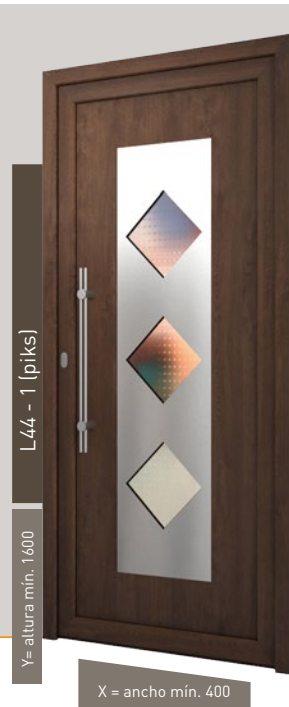





a CANALADA
series



Sorprende por su elegante sencillez, diseño moderno pero con inspiración retro. Las diferentes aplicaciones de acanalados verticales, horizontales, transversales inspiran esta serie.

Los diseños responden a las diferentes separaciones de canal disponibles: 100 y 150 mm. para canal vertical; 100, 200, 400, 500 y 600 mm. para canal horizontal y 100 mm. para el transversal.

El uso de colores lisos y texturados junto con vidrieras de estilos muy marcados dentro de esta serie, puede reforzar el aspecto clásico o moderno de la puerta elegida.

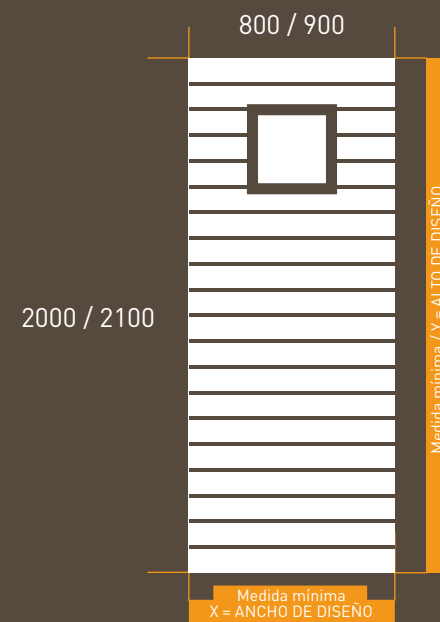



AH-100



AH-100-1V-C (bambú mate)



AH-100-1V-CR (bambú mate)



AH-100-1V-L (kross)



AH-100-1V-LC (origami)



AH-100-1V-LC4 (origami)



AH-100-2 (origami)



AH-200



AH-200-1V-L (cannes)



AH-200-1V-LC (origami)



AH-200-1V-LC4 (piks)



AH-400



AH-400-1V-L (piks)



AH-500



AH-600



A0-100



A0-100-1V (origami)

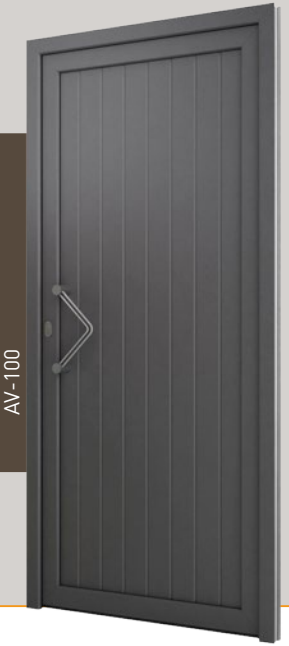

AV-100

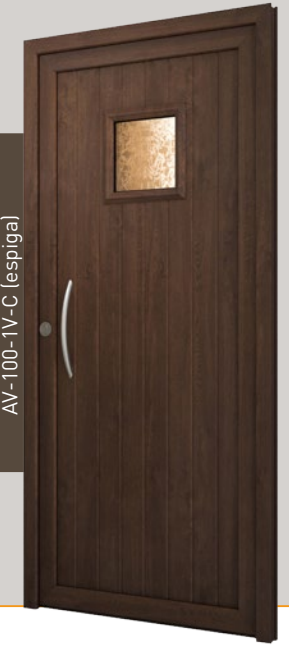

AV-100-1V-C (espiga)

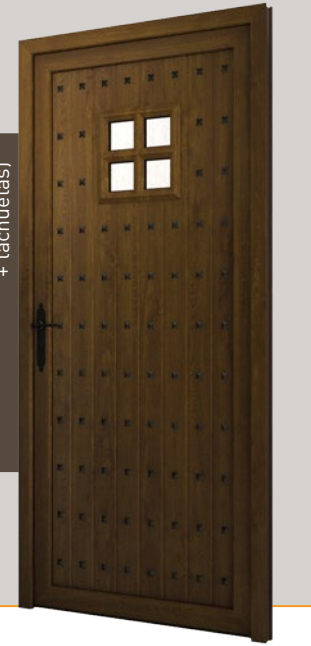

AV-100-1V-CR (bambu mate + tachuelas)



m OLDURA
series



Moldura clásica sobre paneles lisos y vidrios de diferentes tamaños, formas y texturas que admiten varias combinaciones dentro de un mismo modelo para controlar el nivel de luminosidad deseado.

La serie moldura ofrece sorprendentes aplicaciones para crear diseños de diferentes tamaños, formas y resultado estético.

Amplia gama de accesorios anodizados oro, plata, bronce, etc. completan la gama.

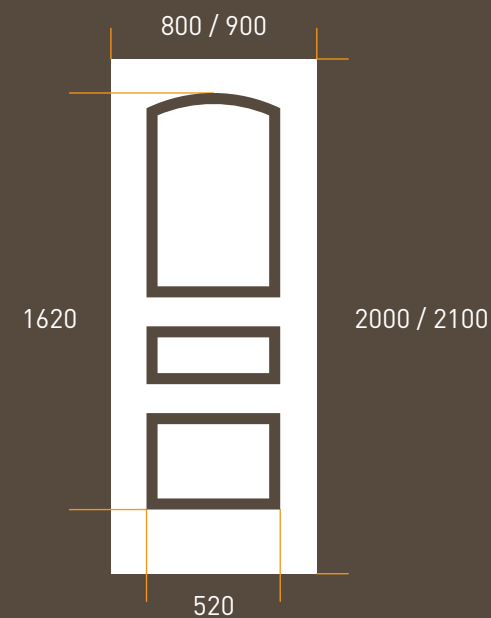





M04 - 4v (pikks)



M05 - 3v (pikks)



M05



M06 - 3v (kross)

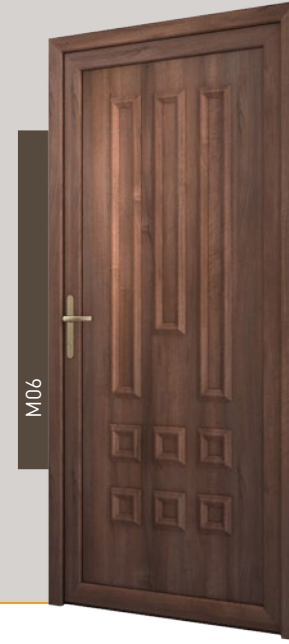

M06

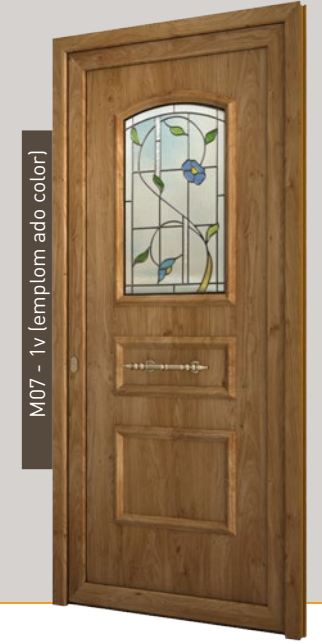

M07 - 1v (emplomado adó color)



M07

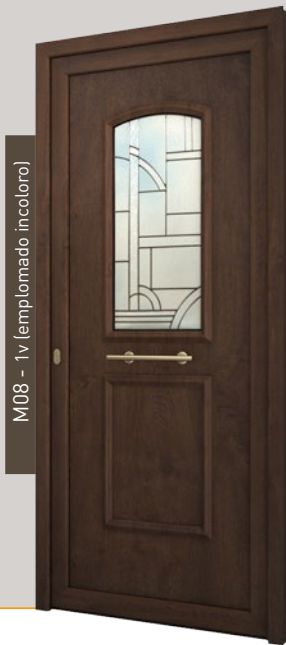

M08 - 1v (emplomado incoloro)



M08 - 2v (kross)



M08

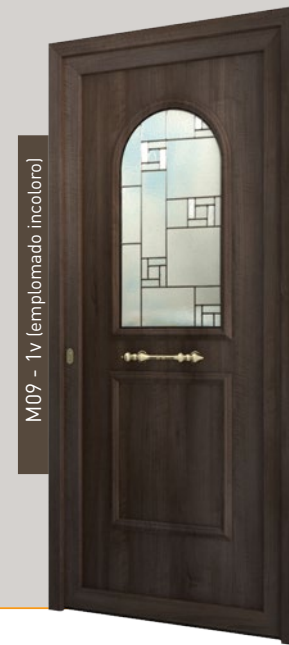

M09 - 1v (emplomado incoloro)

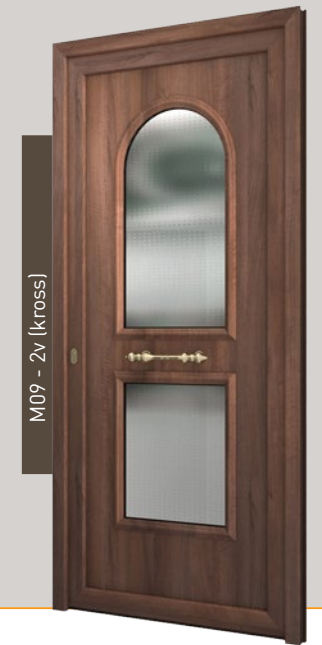

M09 - 2v (kross)

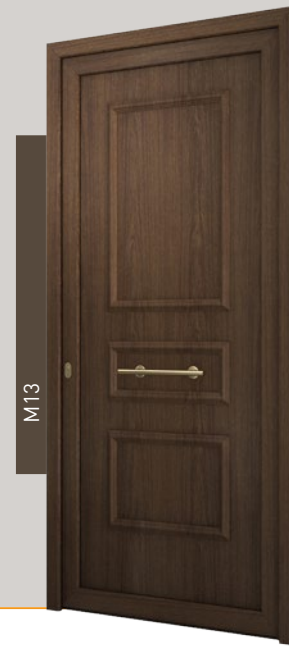
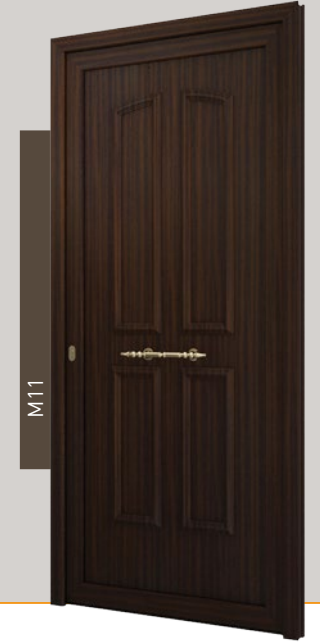
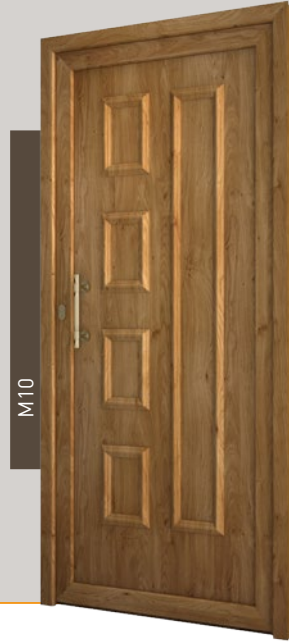
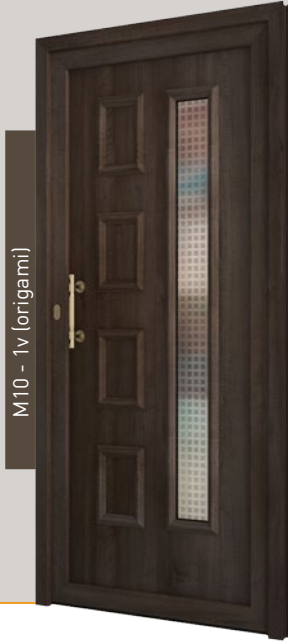



M14

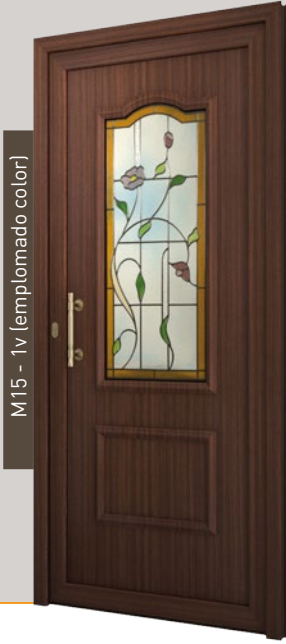

M15 - 1v (emplomado color)

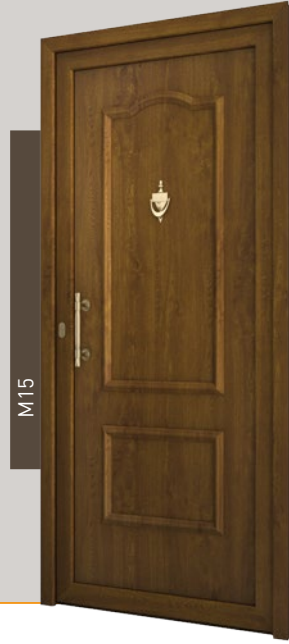

M15



M16 - 2v (kross)



M16 - 4v (piks)



M16 - 6v (kross)



M16



M17 - 4v (origami)



M17 - 6v (piks)

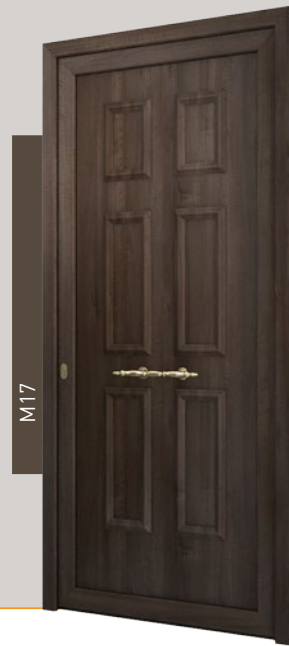

M17



M18 - 2v (escarcha)



M18 - 4v (origami)





M23 - 4v (kross)



M23 - 6v (origami)



M23



M24 - 2v (fussing)

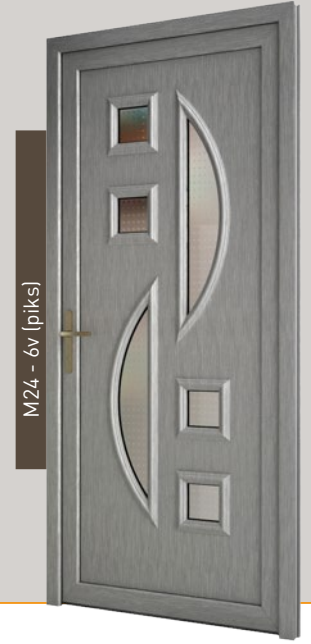

M24 - 6v (pikks)



M24



M25 - 1v (kross)



M25



M26 - 1v (emplomado incoloro)



M26 - 3v (bambú mate)

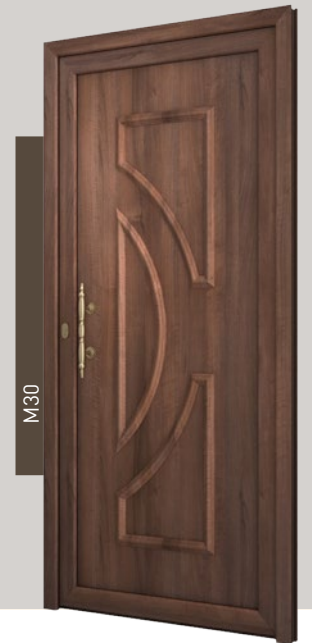
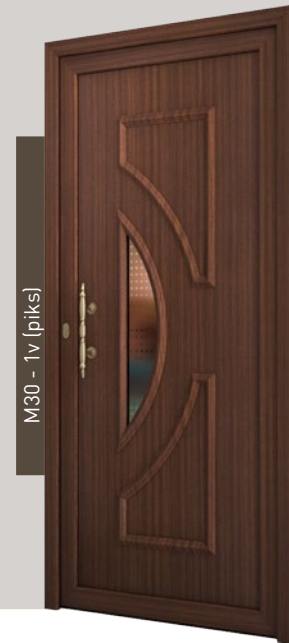
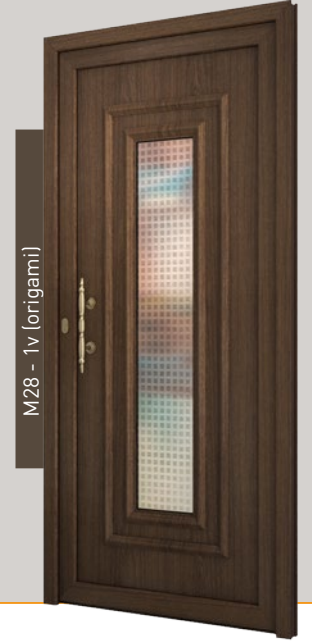



**THERMO
CONFORMADA**
series



La serie termoconformada es una variación de la serie moldura (M) en la que se cambia el proceso de fabricación y material base utilizado.

En la serie termoconformada están disponibles todos los diseños de la serie M ahora identificados con la referencia T. Aquí presentamos los modelos que tienen diferencias respecto a la serie M. Se usa una segunda moldura.

A diferencia de la serie M en la que la moldura va superpuesta en la T el diseño se logra aplicando calor a una plancha de PVC manteniendo intactas sus valores de resistencia y aislamiento. El resultado sin juntas, de formas suaves y agradables al tacto facilita la limpieza de la puerta.

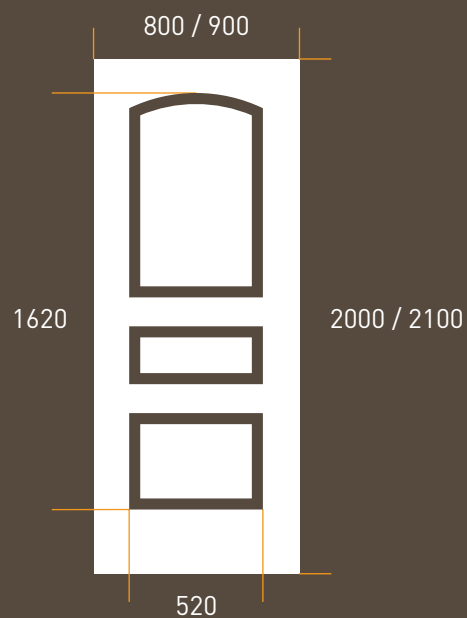



rÚSTICA
series



Las nuevas técnicas y materiales aplicados a la fabricación de puertas hacen posible la existencia de esta serie de puertas muy duraderas y sin los inconvenientes de la madera natural pensadas para proporcionar seguridad y confortabilidad a su hogar.

Una adecuada superposición de molduras con una amplia gama de complementos a juego como tiradores, pomos, rejillas, rejillas, diferentes adornos y vidrieras artísticas hacen de esta serie la más versátil de PANELDESIGN.

Esta serie también está disponible con puertas dobles ciegas o con vidrios.

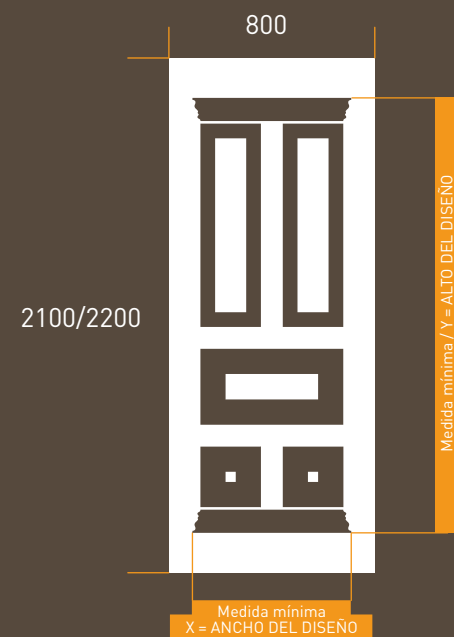



Y = altura mín. 1690

X = ancho mín. 617



Y = altura mín. 1690

X = ancho mín. 617



Y = altura mín. 1675

X = ancho mín. 560



Y = altura mín. 1700

X = ancho mín. 582



Y = altura mín. 1700

X = ancho mín. 582



Y = altura mín. 1690

X = ancho mín. 612



Y = altura mín. 1690

X = ancho mín. 612



Y = altura mín. 1780

X = ancho mín. 570



Y = altura mín. 1780

X = ancho mín. 570

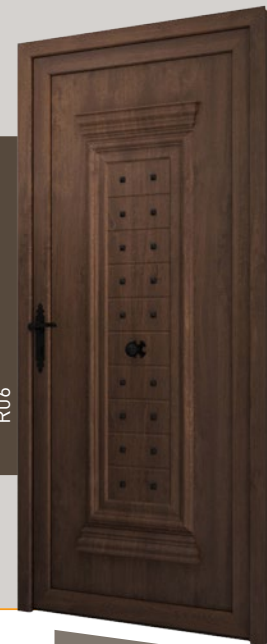

Y = altura mín. 1650

X = ancho mín. 520



Y = altura mín. 1650

X = ancho mín. 520



Y = altura mín. 1650

X = ancho mín. 520





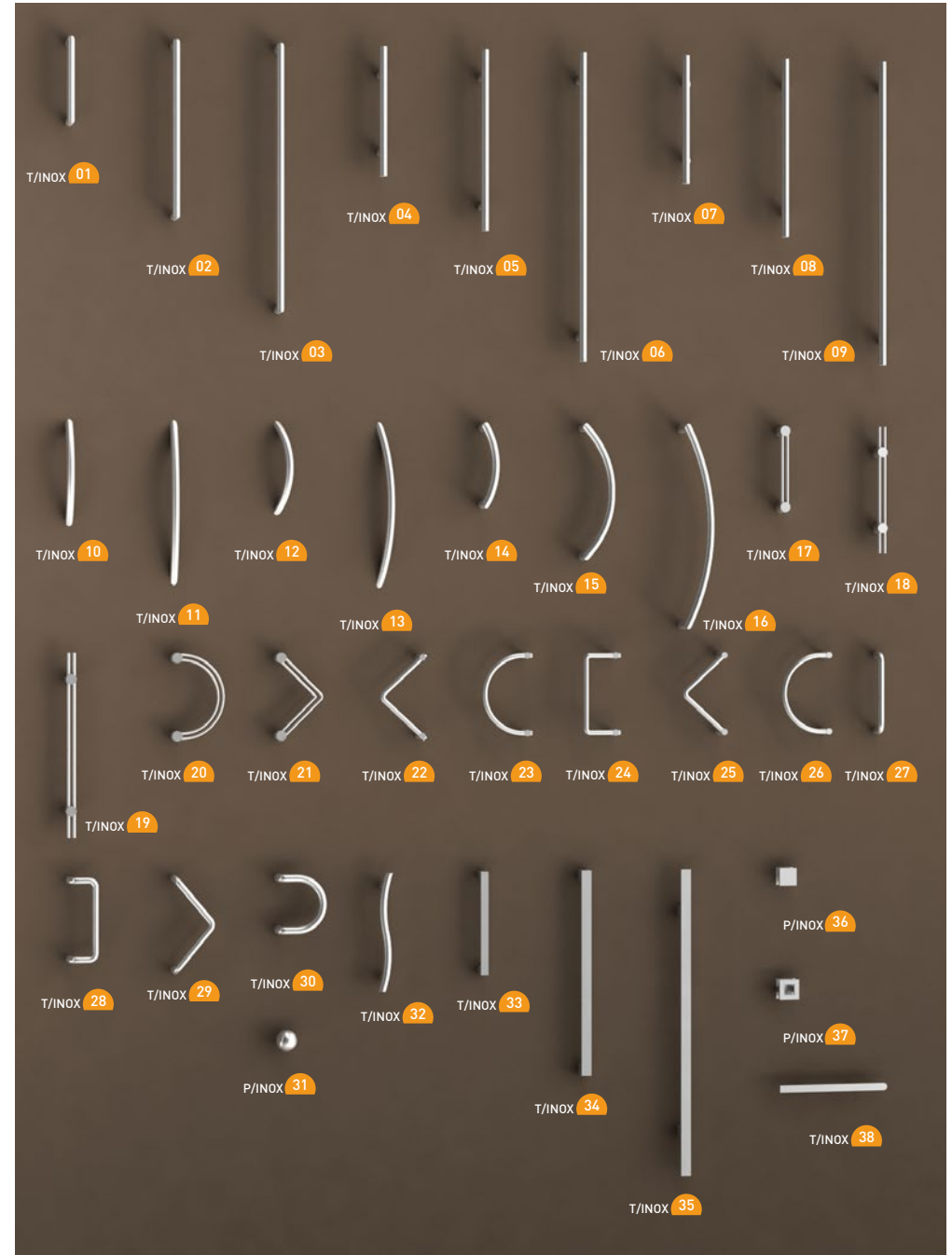
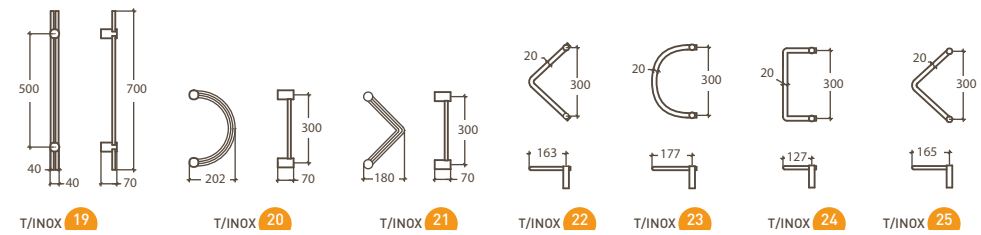
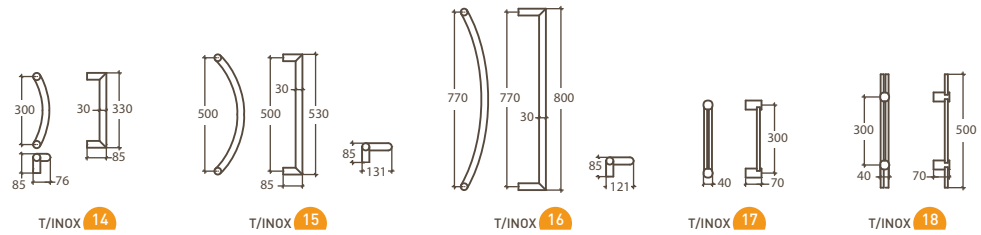
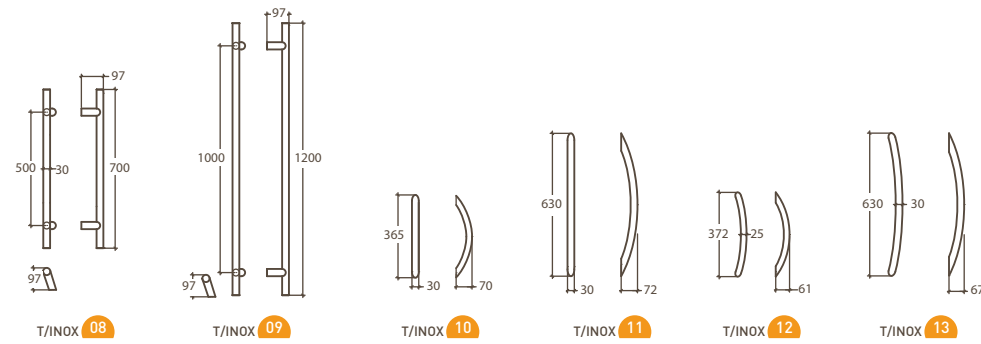
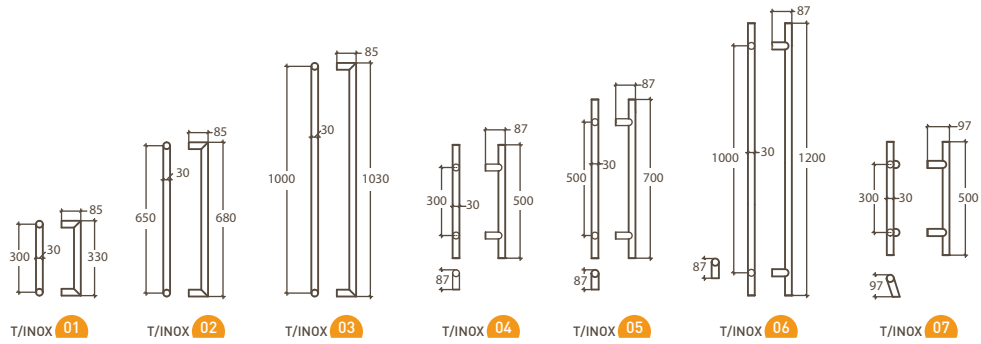

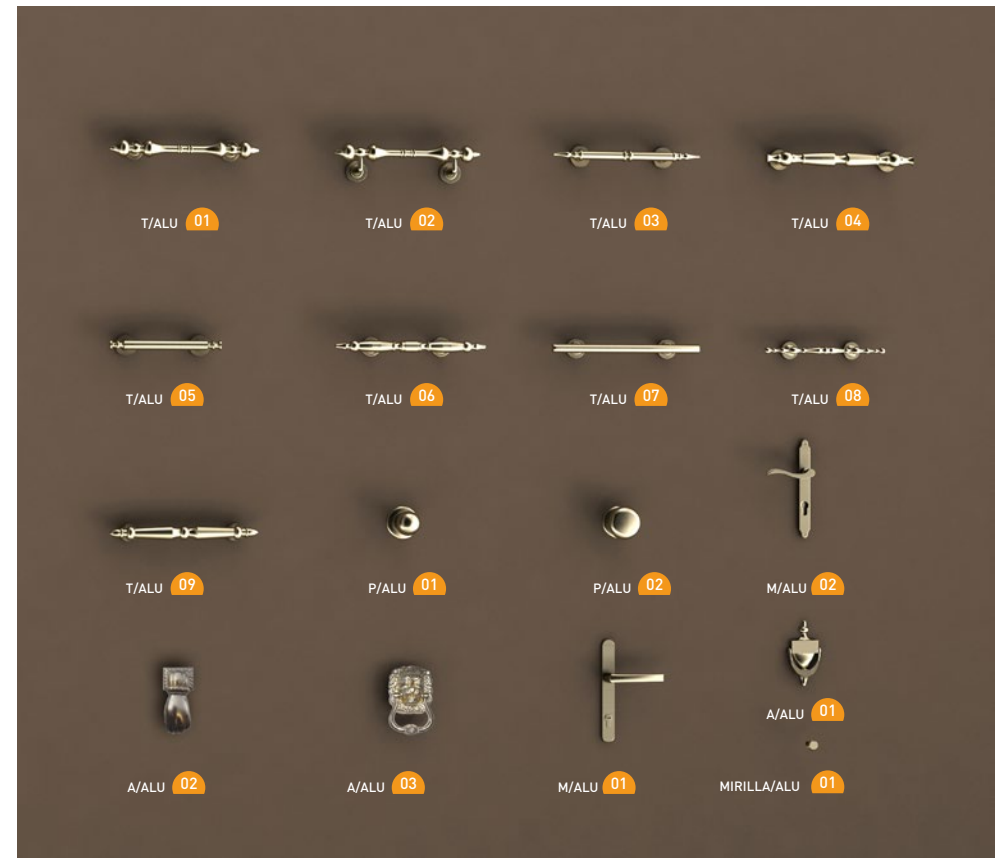
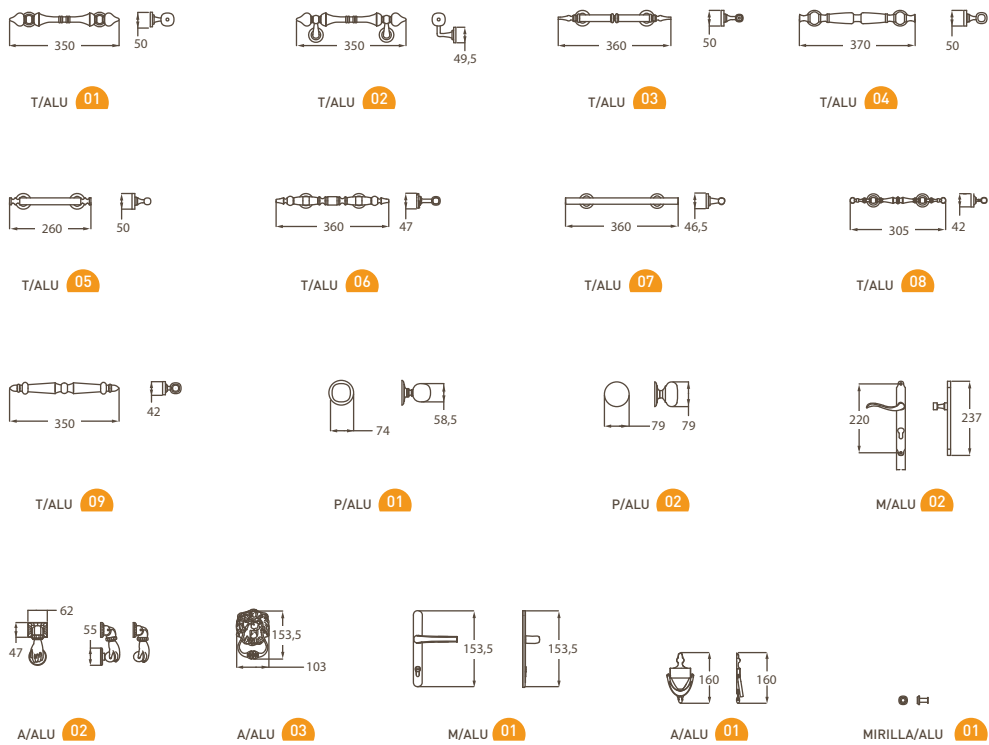
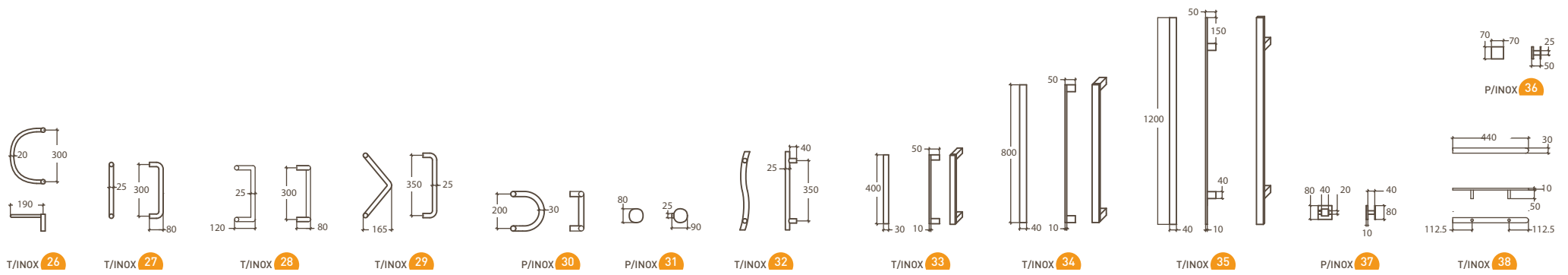

M/FORJA 01
Acabados lisa y martillada

M/FORJA 02
Acabados lisa y martillada

M/FORJA 03
Acabados lisa y martillada

T/FORJA 01
Acabados lisa y martillada

T/FORJA 02
Acabados lisa y martillada

T/FORJA 03
Acabados lisa y martillada

A/FORJA 01

A/FORJA 02

A/FORJA 03

MIRILLA/FORJA 04

TACHUELA 01

TACHUELA 02

TACHUELA 03

TACHUELA 04

TACHUELA 05

TACHUELA 06

M/FORJA 01

M/FORJA 02

M/FORJA 03

T/FORJA 01

T/FORJA 02

T/FORJA 03

A/FORJA 01

A/FORJA 02

A/FORJA 03

MIRILLA/FORJA 04

TACHUELA 01

TACHUELA 02

TACHUELA 03

TACHUELA 04

TACHUELA 05

TACHUELA 06

Serie rústica / Adornos

REJA 01

REJA 02

REJA 03

REJA 04

ROSETA 01

ROSETA 02

ROSETA 03

ROSETA 04



PIKS

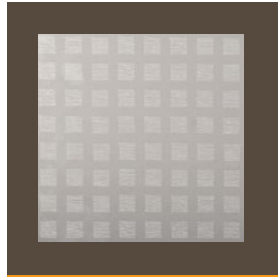

ORIGAMI

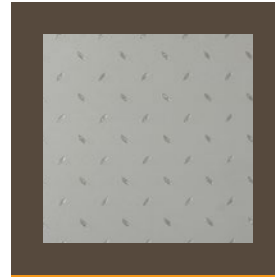

KROSS

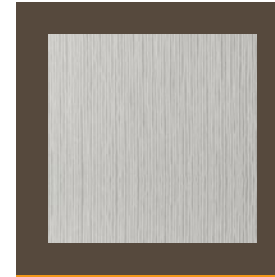

CANNES



REFLEX



MATE



MATE BORDE TRANSP.

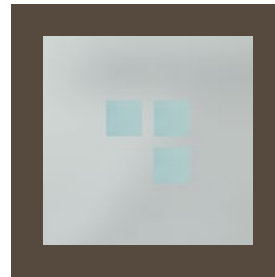

MATE DISEÑO

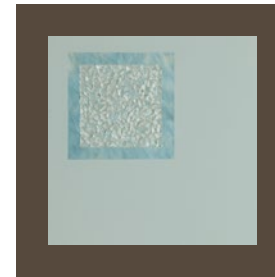

MATE DIAMANTE



BISEL



EMPLOMADO INCOLORO

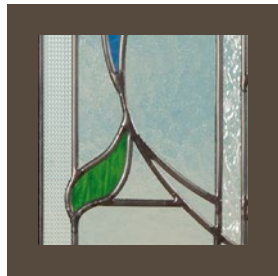

EMPLOMADO COLOR



FUSSING

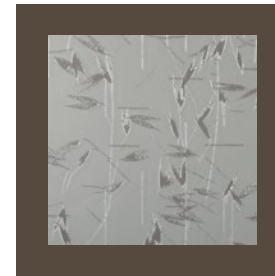

ESPIGA

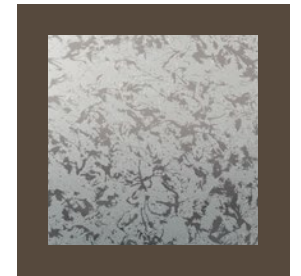

ESCARCHA

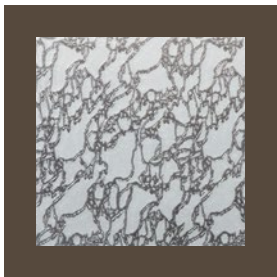

DELTA



DELTA V. BLANCA

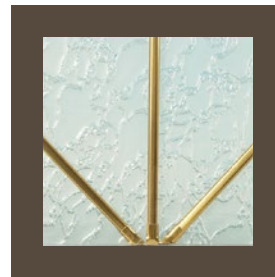

DELTA V. DORADA

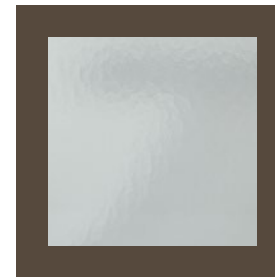

CATEDRAL



BAMBÚ MATE

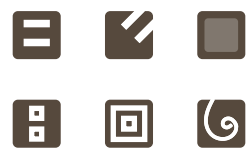



TEL +34 981 695 270
Parque Industrial Midusa.
Anxeriz, 37. 15684 Tordoia.
A Coruña - España.
FAX +34 981 695 269
MAIL info@paneldesign.es



www.paneldesign.es